

Nominal Voltage _____ 12 volts

Amp hour capacity at 20 hour rate _____ 210 amp hour

Reserve Capacity at 25 amp discharge rate _____ 390 minutes

Reserve Capacity at 15 amp discharge rate _____ 680 minutes

Reserve Capacity at 8 amp discharge rate _____ 1375 minutes

Dimensions (inches) _____ Length=20.76*, Width= 8.70, Height= 9.76*

Dimensions (mm) _____ Length=527, Width=221, Height=248

Weight _____ 135 pounds / 61.2 kilograms

Recommended charge voltage _____ Bulk Charge 14.2 – 14.6 volts

_____ Absorption/Acceptance Charge 14.2 - 14.6 volts

_____ Float Charge 13.1 to 13.4 volts

Recommended Charge Amperage _____ Up to 100% of the rated amp hour capacity

Self Discharge Rate _____ 2% per month at 77°F (25°C)

Operating Temperature _____ -50° to 150° F (-45 to 65.5 C)

Cycle life _____ 1,100 cycles to 50% DOD, 500 cycles to 100% DOD

Warranty _____ Refer to manual for warranty information by application



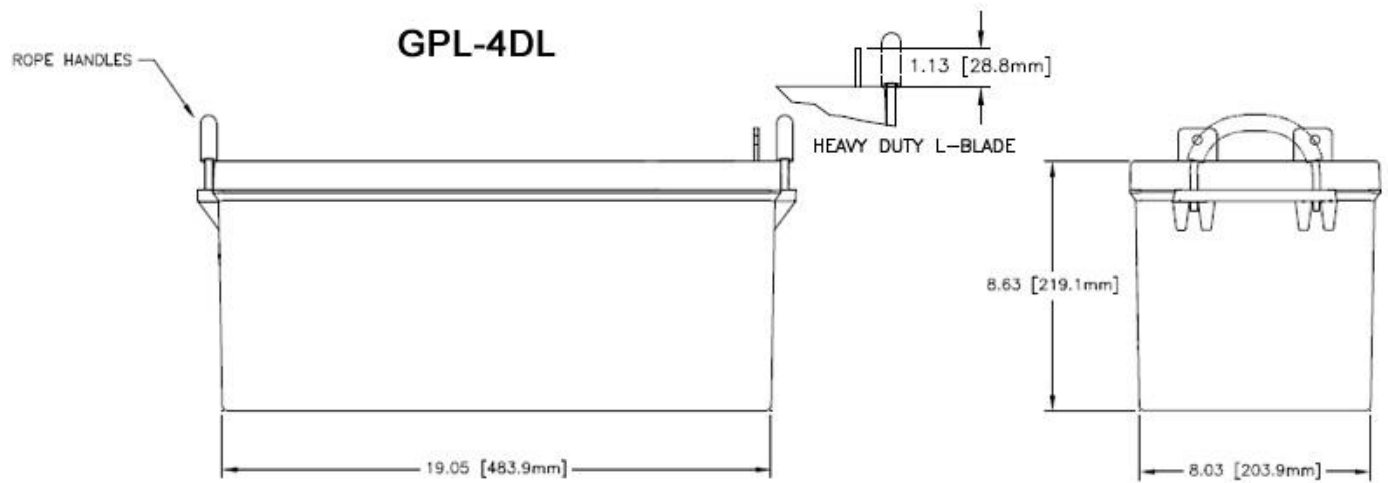

* All dimensions are overall. This will include handles and terminals. Actual case size may be smaller than published.

